

SAE J1939 PRESSURE TRANSDUCER



TYPE: SMC

PROTOCOL DESCRIPTION

CONTENT

content	2
1. GENERAL	3
2. ABBREVIATION INDEX	3
3. CAN BUS TOPOLOGY	3
4. BIT RATE	4
5. NETWORK MANAGEMENT	4
6. CAN MESSAGE FORMAT	4
6.1 Parameter Group Number (PGN)	4
6.1.1 PGN Proprietary A	5
6.1.2 PGN Proprietary B	5
7. USER DATA FORMATS	5
7.1 Interpreting the transmitted pressure values	5
8. THE DEFAULT SETTINGS SET	6
9. SETTINGS PGN	6
9.1 General information	6
9.1.1 Exemplary register read access	7
9.1.2 Unlocking the register write access	8
9.1.3 Exemplary register write access	9
9.2 Register Overview	10
9.2.1 General CAN registers	10
9.2.1.1 0x0001, 0x0002 (Transducer hardware/firmware revision)	10
9.2.1.2 0x0010 (Measurements' endianness)	11
9.2.1.3 0x0020 (J1939 start address)	11
9.2.1.4 0x0040 (Boot-up baud rate)	13
9.2.1.5 0x0050/0x0051 (Milliseconds timestamp)	14
9.2.2 General transducer registers	14
9.2.2.1 0x0100 (Save current settings to EEPROM)	14
9.2.2.2 0x0110 (Reset to factory settings)	14
9.2.2.3 0x0120 (Perform reboot)	15
9.2.3 Primary measuring channel settings	15
9.2.3.1 30 0x0200 ... 0x0219 (Gain and offset parameters)	15
9.2.3.2 0x0220 (Apply current reading as 'zero')	15
9.2.3.3 0x0221 ('zero' value)	15
9.2.4 Measurements-PGN 1 settings	16
9.2.4.1 0x0800 (General PGN settings)	16
9.2.4.2 0x0810 ... 0x0811 (Static mask)	17
9.2.4.3 0x0820 ... 0x0821 (Mapping entries)	17
10. REMARKS	18
11. BIBLIOGRAPHY	19

1. GENERAL

The protocol SAE J1939 is based on CAN.

The documents SAE J1939/1x describe its structure; Chapter 3 contains a general description.

The pressure transducers produced by ADZ NAGANO GmbH are of the ECU-type I. Thus, they do not include bus termination resistors.

2. ABBREVIATION INDEX

CAN	<u>C</u> ontroller Area Network
DA	<u>D</u> estination Address
ECU	<u>E</u> lectronic Control Unit
PDU	<u>P</u> rotocol Data Unit
PGN	<u>P</u> arameter Group Number
SA	<u>S</u> ource Address
SAE	<u>S</u> ociety of Automotive Engineers
SPN	<u>S</u> spect Parameter Number

3. CAN BUS TOPOLOGY

The CAN bus is a linear structure (see Figure 1). All data are transferred in differential mode using two electrical lines (CAN high, CAN low). On both of its ends, the bus requires a termination network (each resistor, 120Ω) to provide a defined idle state.

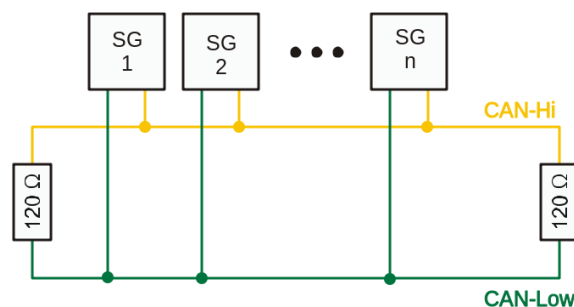

Figure 1: Linear CAN bus topology with terminating resistors [1]

For a limited extent, bus stubs may be used for realizing a star topology. Be aware that in this case, the terminating resistors have to be adjusted.

In combination with the protocol SAE J1939, the bus nodes are called ECUs.

4. BIT RATE

The default bit rate is set to 250kBit/s. For special applications, different bit rates can be realized.

5. NETWORK MANAGEMENT

The network management for SAE-J1939 is described in the document “J1939/81”. In default settings state, the pressure transducer fulfils the minimal requirements for “resolving address conflicts” and “checking for multiple device addresses”. Furthermore, it supports the automatic address alteration during runtime.

The fields for a clear determination of the devices’ functions may be assigned according to the customer’s needs.

6. CAN MESSAGE FORMAT

Figure 2 depicts the CAN message format when using SAE J1939. The CAN-ID contains message priority, PGN and source address.

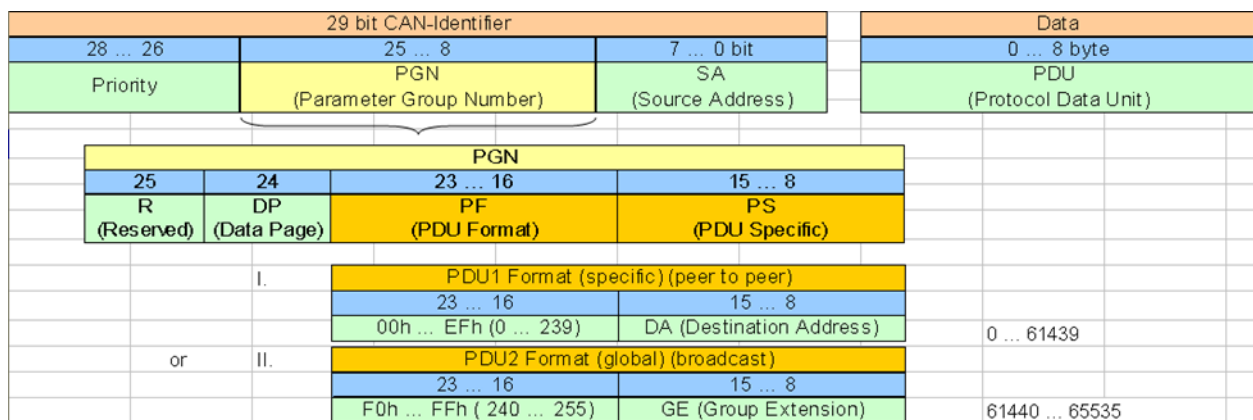

Figure 2: SAE J1939 CAN message format

6.1 Parameter Group Number (PGN)

The Parameter Group Number (PGN) consists of the fields “R” (Reserved), “DP” (Data Page), “PF” (PDU Format) and “PS” (PDU Specific). The first two fields (“R” and “DP”) are not used within the default parameter set and both do contain zeros.

Document SAE J1939/71 defines various PGNs. Each of them has specifically structured payload and other parameters (e.g. repetition time).

The usage of proprietary data formats is possible, as long as the field “PF” is assigned the values 239 (PGN Proprietary A) or 255 (PGN Proprietary B).

6.1.1 PGN Proprietary A

This PGN is used when transferring data in a targeted manner. The field "PS" declares the destination address.

6.1.2 PGN Proprietary B

Broadcast messages use the PGN Proprietary B. In this case, the field "PS" declares supporting payload data formats.

7. USER DATA FORMATS

The user data format must be interpreted according to the used PGN. A PGN may contain one or more SPNs (Suspect Parameter Numbers). The SPN data structure is described by SAE J1939/71.

ADZ NAGANO GmbH pressure transducers by default do use a proprietary data format.

7.1 Interpreting the transmitted pressure values

Each message's data field length is 8 bytes. The first two bytes contain the pressure value; the following bytes are assigned 255 (0xFF). The MSB (Most Significant Byte) will be sent at first (known as Big Endian). Received data need to be multiplied with the Resolution. Subsequently, the Offset is subtracted. Both Resolution and Offset can be found in the pressure transducer's datasheet.

Example:

- Pressure transducer: -1...10bar
- Resolution: 0,01 bar / bit
- Offset: 1 bar
- Pressure: 9,00 bar
- Data bytes (HEX notation): 0x03 0xE8 0xFF 0xFF 0xFF 0xFF 0xFF 0xFF
- Relevant data bytes: 0x03 E8 = 1000_{decimal}

Calculation:

$$\begin{aligned}
 \text{Pressure} &= \text{Pressure}_{\text{Digital}} \cdot \text{Resolution} - \text{Offset} \\
 &= 1000 \cdot 0,01 \frac{\text{bar}}{\text{bit}} - 1 \text{ bar} \\
 &= 9 \text{ bar}
 \end{aligned}$$

8. THE DEFAULT SETTINGS SET

The following table shows a default configuration. Specific configurations and settings may be found in part-number depending product datasheets.

Parameter	Default value	Meaning
Transmission baud rate	250 kBit/s	Transmission speed.
Start address	208 (0xD0)	Assigned address at boot up time.
PGN	65330 (0xFF 32)	Parameter number of data.
Priority	7	Message priority (0 = highest).
Transmission cycle time (also repetition time)	100ms	Repetition time of the pressure messages.
SPN	According to pressure range.	Describes data interpretation.
Manufacturer ID	455 (0x01 C7)	Manufacturer ID of ADZ NAGANO GmbH.
ECU Instance	1	These fields hold the device's function within the system.
Function Instance	3	
Function	4	
Industry Group	5	
Vehicle System	7	
Vehicle System Instance	1	
Arbitrary Address Capable	1	Automatic address obtaining enabled.

9. SETTINGS PGN

9.1 General information

The *Settings PGN* can be used to read and write registers from the *SMC pressure/temperature transducer*. These registers may contain settings or status/informational data, depending on the address that is being accessed.

There are two types of accesses: reading and writing accesses. While writing accesses must be unlocked before using (refer to [section 9.2](#)), read accesses can always be applied.

A typical *Settings PGN* access consists of three important things:

- The *CAN-ID* holding the address of the *J1939* device that is being accessed,
- Register Access Code* (containing one read/write bit and the 15-bit register address; discussed below),
- In case of write access: The *payload data* that shall be written (up to six bytes). The amount of *payload data bytes* (and thus the *DLC*) depends on the register being written to. Important: All multi-byte values need to be ordered as *Little Endian*!

The figure below shows how to assemble the necessary **CAN-ID**:

MSB				LSB
5 bits	8 bits	8 bits	8 bits	
<i>Info field. Typically "0x18"</i>	<i>Must be "0xEF"</i>	<i>Destination Address (see below)</i>	<i>Source Address</i>	

The field *Destination Address* contains the address of the device being accessed. When choosing the value 0xFF combined with subsequent *register write accesses*, all present *SMC pressure/temperature transducer* devices will be configured.

The 16-bit **Register Access Code** consists (as already mentioned above) of two fields:

- 1) A one-bit read/write value located at the *most significant bit*. The value '1' (0x8000 + <register access code>) stands for writing; the value '0' stands for reading access.
- 2) The 15-bit address of the register being accessed. An overview of all available registers can be found at **section 9.2**.

Two more important things:

- Before writing values to any register, the **write access must be unlocked**. In order to unlock write access, refer to **section 9.1.2**.
- Data written to any registers will not automatically be applied to *non-volatile EEPROM*. Thus, the **save process** explicitly must be performed **after applying configuration values**. The save procedure is described in [section 9.2.2.1](#). **It is strongly recommended to wait 500ms after this command to avoid memory corruptions.**

9.1.1 Exemplary register read access

The following figure shows how to build up a CAN message containing a valid read access.

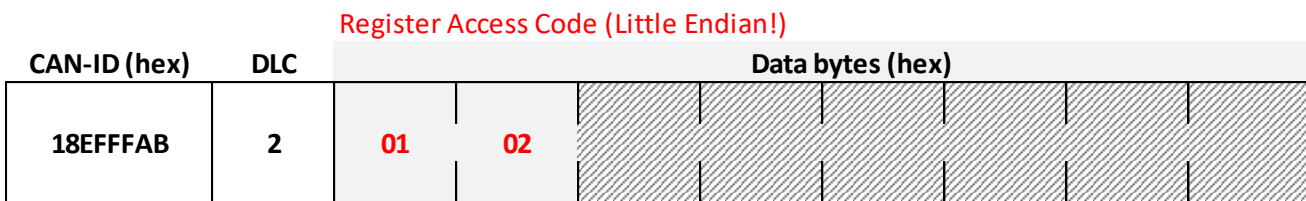

Exemplary access for reading a value from register 0x0201

A possible response to this access could be as follows:

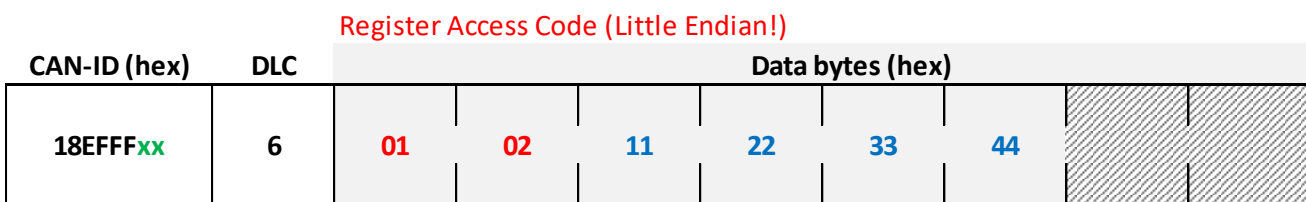

xx stands for the transducer's address Read Value 0x44332211 (in this case int32; Little Endian)

Exemplary response to reading a value from register 0x0201

The amount of data bytes contained in the response depends on the register that was accessed. Refer to the overview of available registers, located at [section 9.2](#).

9.1.2 Unlocking the register write access

Before writing to any registers, the write access must be unlocked. The following CAN message holds the necessary data in order to unlock *all present ADZ J1939 transducers*.

CAN-ID (hex)	DLC	Unlock Code							
		Data bytes (hex)							
18EFFFAB	8	41	44	5A	2B	50	4D	53	54

Unlocking register write access for all present ADZ J1939 transducers

After transferring the message above, each present ADZ J1939 transducer sends out the message below.

CAN-ID (hex)	DLC	Unlock Code							
		Data bytes (hex)							
18EFFFxx	8	41	44	5A	2B	50	4D	53	54

xx stands for the transducer's address

Response after successfully unlocking write access

After performing this procedure, all present transducers' register write access will be *unlocked until reboot*. Alternatively, the access can be manually locked by writing to register 0x0000.

CAN-ID (hex)	DLC	Lock Code							
		Data bytes (hex)							
18EFFFAB	2	00	80						

Locking register write access for all present ADZ J1939 transducers

After transferring the message above, each present ADZ J1939 transducer sends out the message below.

CAN-ID (hex)	DLC	Lock Code							
		Data bytes (hex)							
18EFFFxx	3	00	80	00					

xx stands for the transducer's address

Return Code (0x00 means "success")

Response after successfully locking write access

9.1.3 Exemplary register write access

Requirement: The register write access has already been unlocked (refer to **section 9.1.2**).

The amount of data bytes (and data values) depends on the register that is being accessed. The following CAN message shows how to write exemplary data contents to register 0x0201.

Register Access Code (Little Endian; MSB is "1" [0x8000])

CAN-ID (hex)	DLC	Data bytes (hex)							
18EFFFAB	6	01	82	01	02	03	04		

Data Value 0x04030201 (in this case int32; Little Endian)

Exemplary write access to register 0x0201

In case the *data values were assembled correctly* and *write access is unlocked*, the transducer transfers the following message.

Register Access Code (Little Endian!)

CAN-ID (hex)	DLC	Data bytes (hex)							
18EFFFxx	3	01	02	00					

xx stands for the transducer's address Return Code (0x00 means "success")

Response after successfully writing to register 0x0201

After performing all necessary write accesses, the user might want to save the applied settings to non-volatile EEPROM. Section 9.2.2.1 shows how to do so.

9.2 Register Overview

The following sections describe the accessible entries of the *SMC pressure/temperature transducer's* register set.

15-bit Register address (HEX)	Allowed access types	Description
General CAN registers		
0x0000	W	Locks all further write accesses to any registers
0x0001	R	Transducers hardware revision
0x0002	R	Transducers firmware revision
0x0010	RW	Measurements' endianness
0x0020	RW	J1939 start address
0x0040	W	Boot-up baud rate
0x0050	RW	Milliseconds timestamp – Upper 32 bits
0x0051	RW	Milliseconds timestamp – Lower 32 bits. Access at first!
General transducer registers		
0x0100	W	Save current settings to EEPROM
0x0110	W	Reset to factory settings
0x0120	W	Perform reboot
Primary measuring channel settings		
0x0200	RW	Gain (Float32)
0x0201	RW	Gain (Int32)
0x0210	RW	Offset (Float32)
0x0211	RW	Offset (Int32)
0x0220	W	Apply current readings as 'zero'
0x0221	RW	'Zero' value
Measurements-PGN 1 settings		
0x0800	RW	General PGN settings
0x0810	RW	Static mask 1
0x0811	RW	Static mask 2
0x0820	RW	Mapping entries 1
0x0821	RW	Mapping entries 2

9.2.1 General CAN registers

9.2.1.1 0x0001, 0x0002 (Transducer hardware/firmware revision)

These *read-only* registers hold the hardware/firmware revision (each Uint16). The returned decimal values are encoded in the following manner: **YYWW** where **YY** corresponds to the year, **WW** to the week.

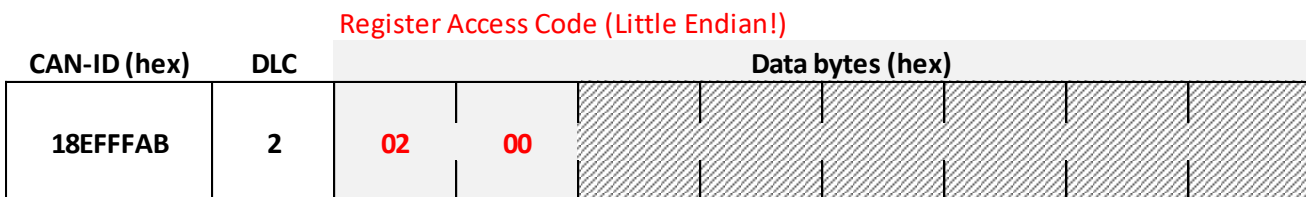

Exemplary access for reading a value from register 0x0002

After transferring the message above, each present ADZ J1939 transducer sends out the message below.

Register Access Code (Little Endian!)

CAN-ID (hex)	DLC	Data bytes (hex)							
18EFFFxx	4	02	00	8E	07				

xx stands for the transducer's address Data Value (in this case int16; Little Endian)

Response after successfully reading register 0x0002

9.2.1.2 0x0010 (Measurements' endianness)

This register changes the endianness of all measurement values.

Type of data value	Possible values	Notes
Uint8	0x00 ... 0x01	0x00: Little Endian 0x01: Big Endian

Register Access Code (Little Endian; MSB is "1" [0x8000])

CAN-ID (hex)	DLC	Data bytes (hex)							
18EFFFAB	3	10	80	01					

Data Value 0x01 (Big Endian)

Exemplary write access to register 0x0010

After transferring the message above, each present ADZ J1939 transducer sends out the message below.

Register Access Code (Little Endian!)

CAN-ID (hex)	DLC	Data bytes (hex)							
18EFFFxx	3	10	80	00					

xx stands for the transducer's address Return Code (0x00 means "success")

Response after successfully changing the endianness of all measurement values

9.2.1.3 0x0020 (J1939 start address)

This register allows to access the current J1939 start address used for *address claiming process*.

The amount of data values differs when reading / writing – that's why both access types will be discussed separately.

Read access:

Type of data value	Possible values	Notes
Uint8	0x00 ... 0xFD	Contains the start address

Register Access Code (Little Endian!)

CAN-ID (hex)	DLC	Data bytes (hex)							
18EFFFAB	2	20	00						

Exemplary access for reading a value from register 0x0020

After transferring the message above, each present ADZ J1939 transducer sends out the message below.

Register Access Code (Little Endian!)

CAN-ID (hex)	DLC	Data bytes (hex)							
18EFFFxx	3	20	00	xx					

xx = transducer's address

Exemplary response to reading a value from register 0x0020

Write access:

Type of data value	Possible values	Notes
Uint8	0x00 ... 0xFD	Contains the start address
Uint8	0x00 or 0x01	Makes (if 0x01) the transducer perform <i>address claiming</i> immediately after writing.

Register Access Code (Little Endian; MSB is "1" [0x8000])

CAN-ID (hex)	DLC	Data bytes (hex)							
18EFFFAB	4	20	80	5B	01				

5B = transducer's NEW start address

01 = perform address claiming

Set transducer's start address to 5B and perform address claiming immediately after writing

After transferring the message above, each present ADZ J1939 transducer sends out the message below.

Register Access Code (Little Endian!)

CAN-ID (hex)	DLC	Data bytes (hex)								
18EFFFxx	3	20	80	00						

xx stands for the transducer's OLD address Return Code (0x00 means "success")

Response after successfully changing the start address

9.2.1.4 0x0040 (Boot-up baud rate)

This register changes the baud rate at boot-up. A change of this register do not change the baud rate immediately.

Type of data value	Possible values	Note
Uint8	0x01 ... 0x08	0x01: 20 kBit/s 0x02: 50 kBit/s 0x03: 100 kBit/s 0x04: 125 kBit/s 0x05: 250 kBit/s 0x06: 500 kBit/s 0x07: 800 kBit/s 0x08: 1 MBit/s

Register Access Code (Little Endian; MSB is "1" [0x8000])

CAN-ID (hex)	DLC	Data bytes (hex)								
18EFFFAB	3	40	80	04						

Data Value 0x04

Changing boot-up baud rate to 125kBit/s

After transferring the message above, each present ADZ J1939 transducer sends out the message below.

Register Access Code (Little Endian!)

CAN-ID (hex)	DLC	Data bytes (hex)								
18EFFFxx	3	40	80	00						

xx stands for the transducer's address Return Code (0x00 means "success")

Response after successfully changing the boot-up baud rate

9.2.1.5 0x0050/0x0051 (Milliseconds timestamp)

These registers are incremented every millisecond automatically and they can be mapped to a PGN. So it is possible to transmit timestamps and process values together. After power on the register will be initialized with 0. Register 0x0050 held the upper 32 bit of the 64 bit timestamp. With a write access it is possible to synchronize the timestamp to a higher ranking system.

NOTE: For read/write access to these registers it is highly recommended to access register 0x0051 at first.

9.2.2 General transducer registers

9.2.2.1 0x0100 (Save current settings to EEPROM)

An access to this register saves all settings to EEPROM and makes them available through a reset of the transducer. **It is strongly recommended to wait 500ms after this command to avoid memory corruptions.**

Register Access Code (Little Endian; MSB is "1" [0x8000])

CAN-ID (hex)	DLC	Data bytes (hex)							
18EFFFAB	2	00	81						

Save all changes / current settings to EEPROM

After transferring the message above, each present ADZ J1939 transducer sends out the message below.

Register Access Code (Little Endian!)

CAN-ID (hex)	DLC	Data bytes (hex)							
18EFFFxx	3	00	81	00					

xx stands for the transducer's address
Return Code (0x00 means "success")

Response after successfully saving

9.2.2.2 0x0110 (Reset to factory settings)

An access to this register resets all settings to the factory defaults.

Register Access Code (Little Endian; MSB is "1" [0x8000])

CAN-ID (hex)	DLC	Data bytes (hex)							
18EFFFAB	2	10	81						

Reset all settings to the factory defaults

After transferring the message above, each present ADZ J1939 transducer sends out the message below.

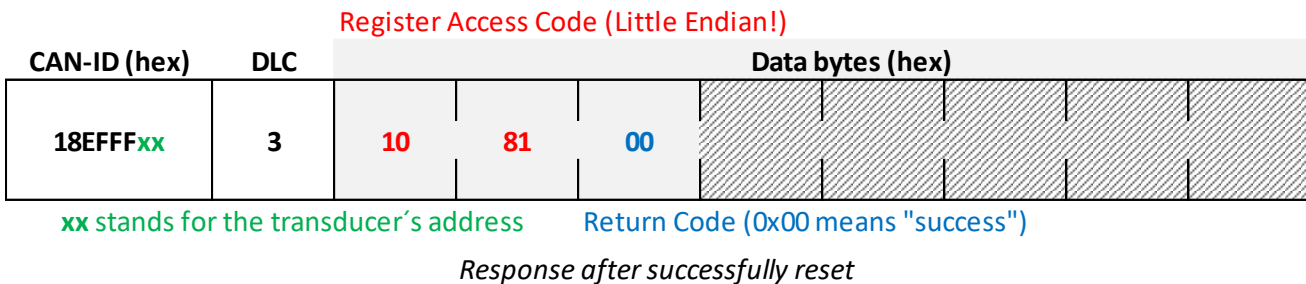

9.2.2.3 0x0120 (Perform reboot)

An access to this register performs a reboot of the transducer. All changes which are not saved will be lost.

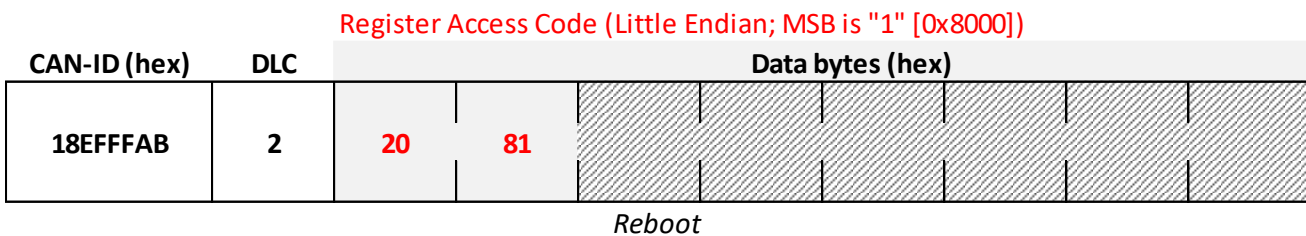

9.2.3 Primary measuring channel settings

9.2.3.1 30 0x0200 ... 0x0219 (Gain and offset parameters)

These registers enable the user to manipulate the output values' scaling settings. The following image shows the linear scaling procedure.



The transducer's nominal measuring range corresponds to the internal *Field Value* range of [0 ... 20000]. Using the *gain* and *offset* parameters, these internal values are being scaled according to the following formula:

$$y = Gain \cdot x + Offset \quad \text{with } x = \text{Field Value} \\ y = \text{Process Value}$$

Both *gain* and *offset* parameters can be read and written as Int32 or Float32 data types.

9.2.3.2 0x0220 (Apply current reading as 'zero')

An access to this register starts an offset compensation. The actual reading will be used as offset reading.

9.2.3.3 0x0221 ('zero' value)

This register holds the actual value for the offset compensation.

Type of data value	Possible values	Note
Int16	-32768..32767	Value for offset compensation

9.2.4 Measurements-PGN 1 settings

The following sub-sections explain all necessary registers enabling the user to configure *measurements-PGN 1*.

9.2.4.1 0x0800 (General PGN settings)

This register allows to access general settings of *measurements-PGN 1*. The register contents consist of 6 data bytes; the following table shows how to assemble the register contents.

Type of data value	Possible values	Note
UInt8		PDU Format
UInt8		PDU Specific
UInt16		PGN transmission rate in milliseconds.
UInt8		<u>Split up 4+4 bits:</u> - The uppermost 4 bits contain priority (possible values 0x0..0x7) - The lowermost 4 bits contain the PGN Data Page ("DP"). 0x0 → DP = 0; 0x1 → DP=1
UInt8		<u>Splits up to 4+4 bits:</u> - The uppermost 4 bits contain the flag <i>AutostartEnabled</i> (0x8 = Enabled). - The lowermost 4 bits contain the PGN Data Length Code ("DLC").

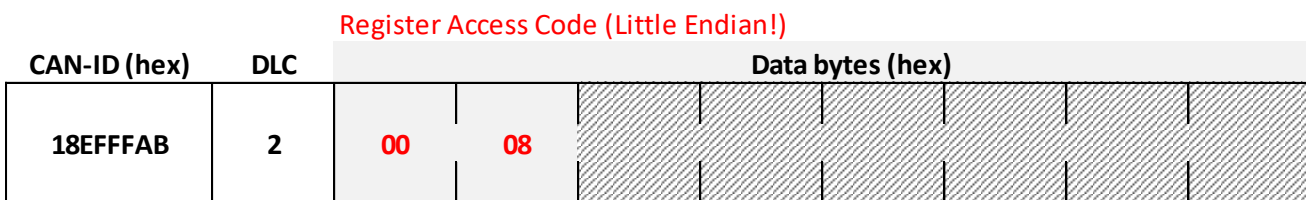

Read PGN settings

After transferring the message above, each present ADZ J1939 transducer sends out the message below.

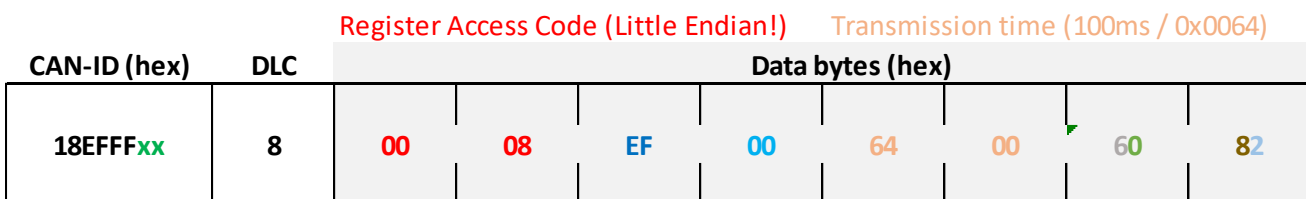

xx stands for the transducer's address PDU Format Priority Autostart
 PDU Specific Data Page DLC

9.2.4.2 0x0810 ... 0x0811 (Static mask)

These register held values which are copied to the PGN message before a transmission is started. The intention is to applied static values to a message. The values are overwritten from the Mapping entries. Refer **section 9.2.4.3** for an example.

Register 0x0810 (Format: Little Endian)

CAN-ID (hex)	DLC	Data bytes (hex)							
XXXXXXXX	x	xx	xx	xx	xx	xx	xx	xx	xx

Register 0x0811 (Format: Little Endian)

Assignment static mask bytes vs PGN - message

9.2.4.3 0x0820 ... 0x0821 (Mapping entries)

The intention of these register is to design the structure of the PGN which is send. The possible data and their identification number is listed in the table below.

Value (dec)	Value (hex)	Size	Usage
0	0	Uint8	Data of this Position is not overwritten
1	1	Uint8	Status of transducer
		Uint32	LSB of Timestamp in Millisecond
3	3	Uint64	Timestamp in millisecond
5	5	Uint32	ADZ – serial number without “Z”
6	6	Uint64	ADZ – serial number without “Z”
7	7	Uint8+Uint32	ADZ – serial number with “Z”
11	B	Uint32	user serial number
12	C	Uint64	user serial number
40	28	Int16	Field value primary channel
41	29	Int16	Process value primary channel
42	2A	Int32	Process value primary channel
43	2B	Float32	Process value primary channel
50	32	Int16	Field value secondary channel
51	33	Int16	Process value secondary channel
52	34	Int32	Process value secondary channel
53	35	Float32	Process value secondary channel

The assignment between the registers and the PGN is shown below.

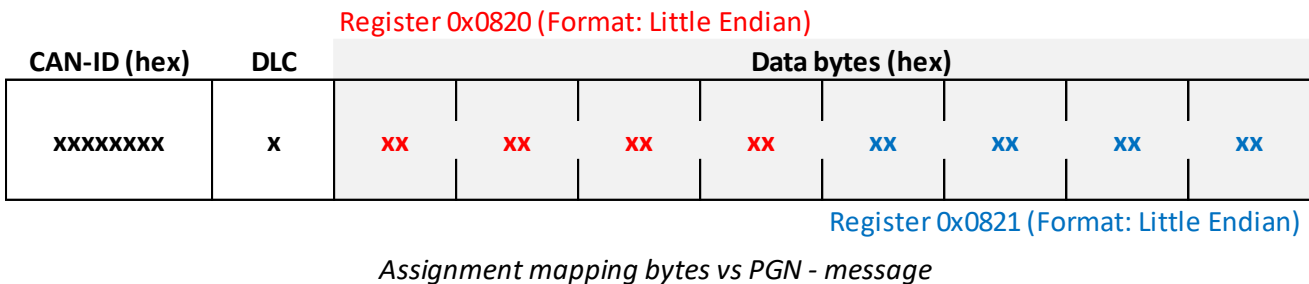

The internal order of assigning a PGN – message is:

- Allocating a buffer with 8 Byte
- Copying the static mask to the buffer
- Copying the values to the PGN correspondent the mapping registers. If the mapping has the value 0 the equivalent byte of the PGN is not changed.

Note: If the mapped data is greater than Uint8 the followed mapping Bytes must be set to 0 to prevent an overwriting of the Data.

Example:

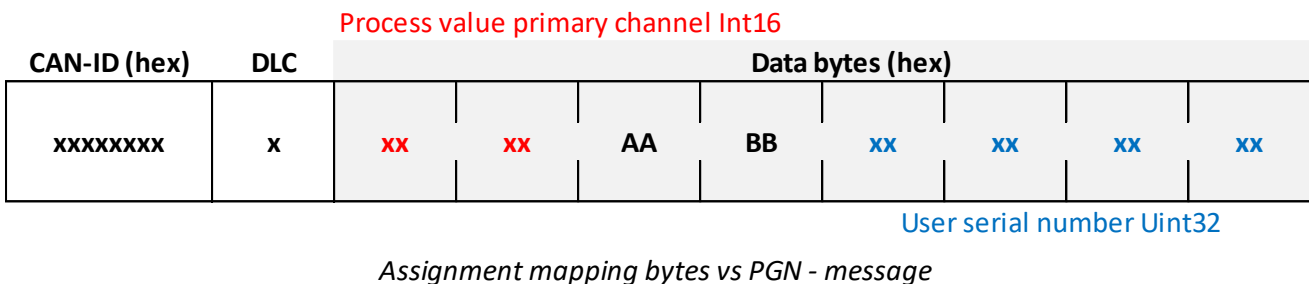

To design the structure of the shown message the mapping and static mask register have following values:

register	value
Static mask 1 (0x0810)	0xBBAFFFFF
Static mask 2 (0x0811)	0xFFFFFFFF
Mapping entries 1 (0x0820)	0x00 00 00 29
Mapping entries 2 (0x0821)	0x00 00 00 0B

10. REMARKS

The behaviour described in this document corresponds to the internal standard of ADZ NAGANO GmbH.

It is possible to alter the behaviour according to the customer’s needs, so that the pressure transducer may be installed easily to the target application.

11. BIBLIOGRAPHY

- [1] Stefan-Xp, "Wikimedia Commons (CC BY-SA 3.0)," 24 Nov. 2016.
[Online]. Available: <https://commons.wikimedia.org/w/index.php?curid=3607670>.